

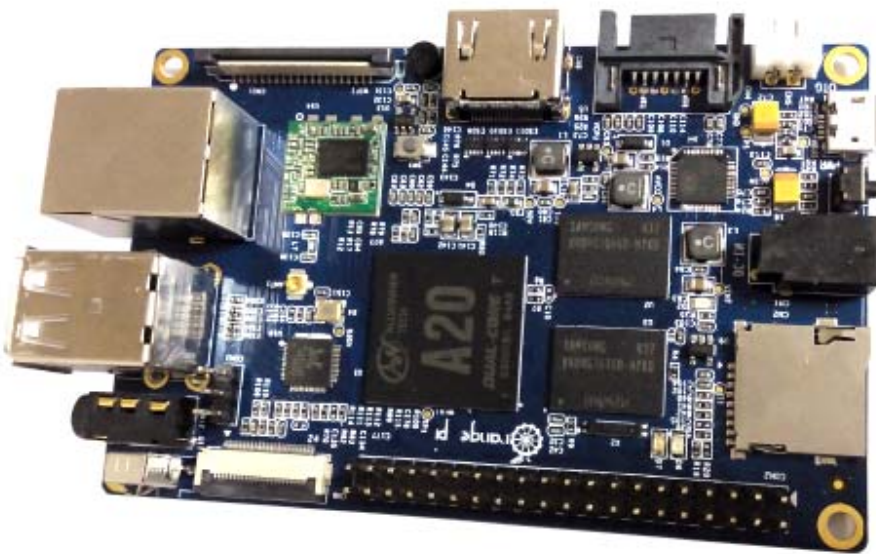

Orange PI Mini User Manual

<Version: V1.0 >





What's Orange Pi Mini?

It's an open-source single-board computer. It can run Android 4.4, Ubuntu, Debian, Raspberry Pi Image, Cubieboard Image, as well as the banana pi Image. It uses the AllWinner A20 SoC, and has 1GB DDR3 SDRAM

What can I do with Orange Pi mini?

Build...

A computer

A wireless server

Games

Music and sounds

HD video

A speaker

Android

Scratch

Pretty much anything else, because Orange Pi Mini is open source

Who's it for?

Orange Pi mini is for anyone who wants to start creating with technology – not just consuming it. It's a simple, fun, useful tool that you can use to start taking control of the world around you.



Hardware Specification

Soc	Allwinner® A20(sun 7i)
CPU	ARM® Cortex™-A7 Dual-Core1GHz (ARM v7 instruction set)
GPU	Mali400MP2 Complies with OpenGL ES 2.0/1.1 (hardware acceleration support)
SDRAM	1GB DDR3 (shared with GPU)
Power	5V @ 2A via MicroUSB (DC in Only) and/or MicroUSB (OTG)
PMU	AXP209

Features

Low-level peripherals	40 Pins Header,compatible with Raspberry Pi B+ 28×GPIO, some of which can be used for specific functions including UART, I2C, SPI, PWM, CAN, I2S, SPDIF, LRADC, ADC, LINE-IN,FM-IN,HP-IN.
On board Network	10/100/1000Mbps ethernet (Realtek RTL8211E)
Wifi Module	WiFi 802.11 b/g/n(RTL8188ETV)
On board Storage	Two MicroSD (TF) card, SATA 2.0
Display	Supports multi-channel HD display: HDMI 1.4 (Type A - full) LVDS/RGB/CPU display interface (DSI) for raw LCD panels Composite video (PAL and NTSC) (via 3.5 mm TRRS jack shared with audio out) 11 HDMI resolutions from 640×480 to 1920×1080 plus various PAL and NTSC standards



Video	HD H.264 2160p video decoding Multi-format FHD video decoding, including Mpeg1/2, Mpeg4, H.263, H.264, etc H.264 high profile 1080p@30fps or 720p@60fps encoding
Audio outputs	HDMI,analog audio (via 3.5 mm TRRS jack shared with composite video out), I2S audio (also potentially for audio input)
Camera	Parallel 8-bit camera interface
Audio input	On board micphone
USB	2 USB 2.0 host, 1 USB 2.0 OTG (all direct from A20 chip)
Buttons	Reset button Power button U-boot button
Leds	Power status led (red) Ethernet status led (blue) User defined led (green)
Other	IR reciever

Interface definition

Sizes	94 mm × 59mm
Weight	45g

Orange Pi™ is a trademark of the Shenzhen Xunlong Software CO., Limited

Hardware



Top view:

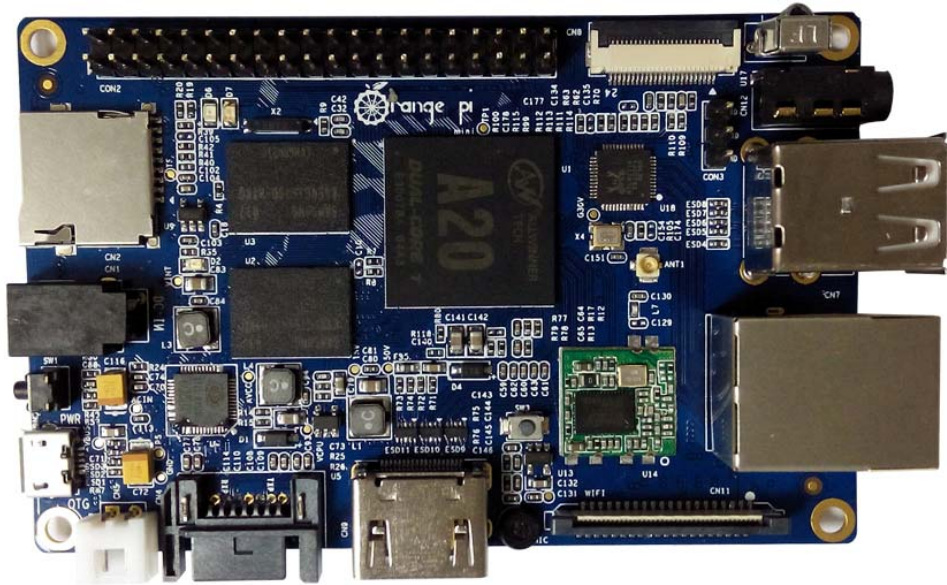

Bottom view:

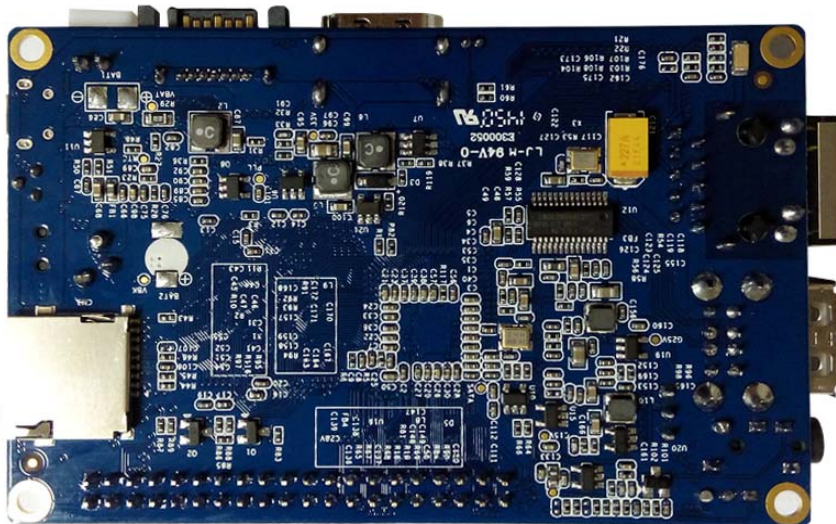

Interface:



Top view

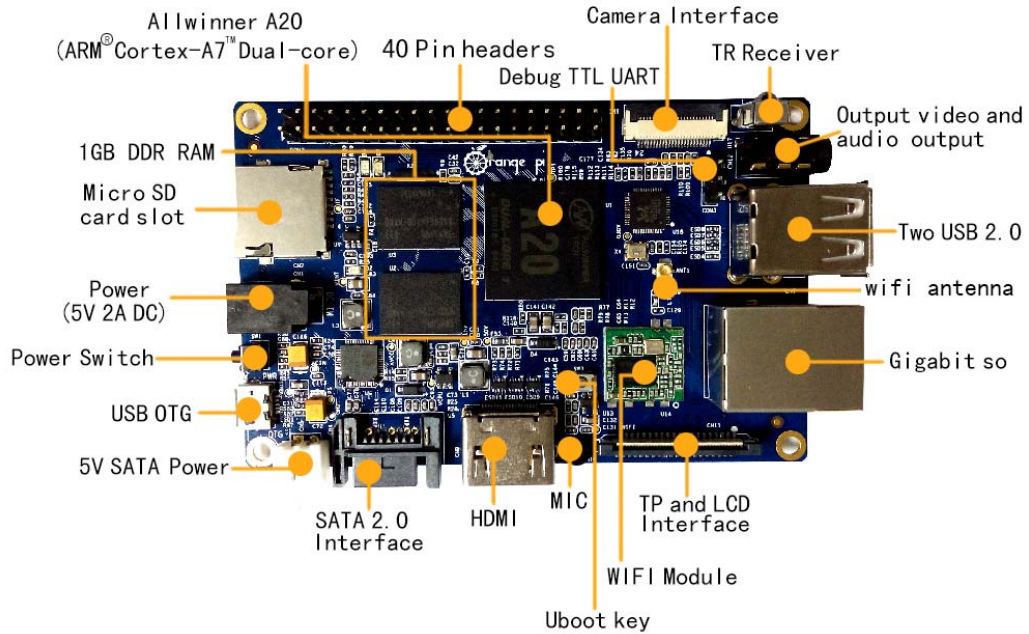

Bottom view

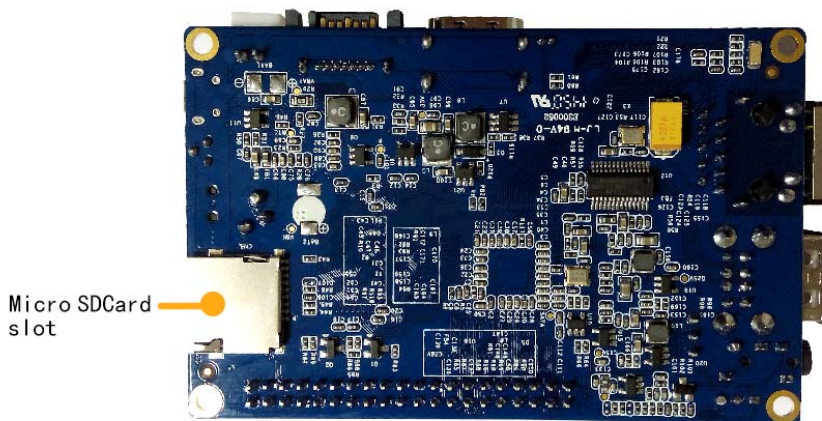

Step 1: Get what you need



First time to enjoy your Orange Pi, you need at least the accessories in the table below.

No.	Item	Minimum recommended specification & notes
1	TF card	<ul style="list-style-type: none">• Minimum size 4Gb; class 4 (the class indicates how fast the card is).• We recommend using branded TF cards as they are more reliable.
2a	HDMI(Full sized) to HDMI / DVI lead	<ul style="list-style-type: none">• HDMI to HDMI lead (for HD TVs and monitors with HDMI input). OR HDMI to DVI lead (for monitors with DVI input).
2b	AV video lead	<ul style="list-style-type: none">• A standard AV video lead to connect to your analogue display if you are not using the HDMI output.
3	Keyboard and mouse	<ul style="list-style-type: none">• Any standard USB keyboard and mouse should work.• Keyboards or mice that take a lot of power from the USB ports, however, may need a powered USB hub. This may include some wireless devices.
4	Ethernet cable/USB WiFi(Optional)	<ul style="list-style-type: none">• Networking is optional, although it makes updating and getting new software for your Orange Pi much easier.
5	Micro USB power adapter	<ul style="list-style-type: none">• A good quality, micro USB power supply that can provide at least 2A at 5V is essential.• Many mobile phone chargers are suitable—check the label on the plug.
6	Audio lead (Optional)	<ul style="list-style-type: none">• You can choose a 3.5mm jack audio led to connect to audio port to get stereo audio.
7	Mobile Hard disk (Optional)	<ul style="list-style-type: none">• You can choose to connect a mobile hard disk to SATA port to store more files.



HDMI to HDMI lead



HDMI to DVI lead



AV video lead



TF card



Micro USB power adapter

Step2: Prepare your TF card for the Orange Pi

In order to enjoy your Orange Pi, you will need to install an Operating System (OS) onto an TF card. Instructions below will teach you how to write an OS image to your TF card under Windows and Linux.

Windows:

1. Insert your TF card into your computer. The size of TF should be larger than the OS image size, generally 4GB or greater.
2. Format the TF card.
 - i. Download the a TF card format tool such as **TF Formatter** from https://www.sdcard.org/downloads/formatter_4/eula_windows/
 - ii. Unzip the download file and run the setup.exe to install the tool on your machine.
 - iii. In the "Options" menu, set "FORMAT TYPE" option to QUICK, "FORMAT SIZE ADJUSTMENT" option to "ON".

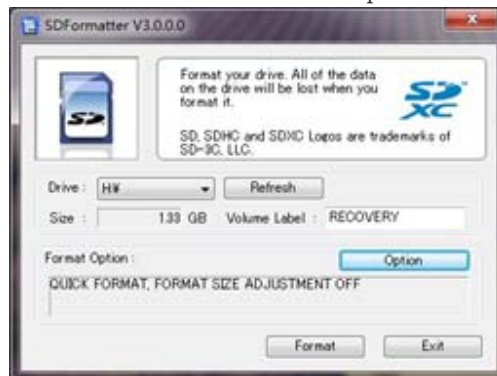

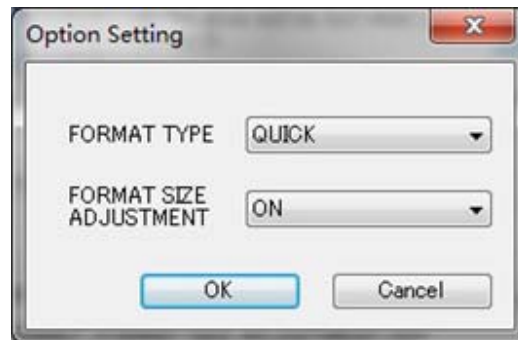

- iv. Check that the TF card you inserted matches the one selected by the tool.
 - v. Click the “Format” button.
3. Download the OS image from the Downloads webpage.
- i. Website: <http://www.orangepi.org/downloaded/download.html>
4. Unzip the download file to get the OS image (**exclude android os image, android os image need other burn mode.**)
- Right click on the file and choose “Extract all”.
5. Write the image file to the TF card.
- i. Download a tool that can write image to TF card, such as **Win32 Diskimager** from:
<http://sourceforge.net/projects/win32diskimager/files/Archive/>
 - ii. Open the unzipped image file.

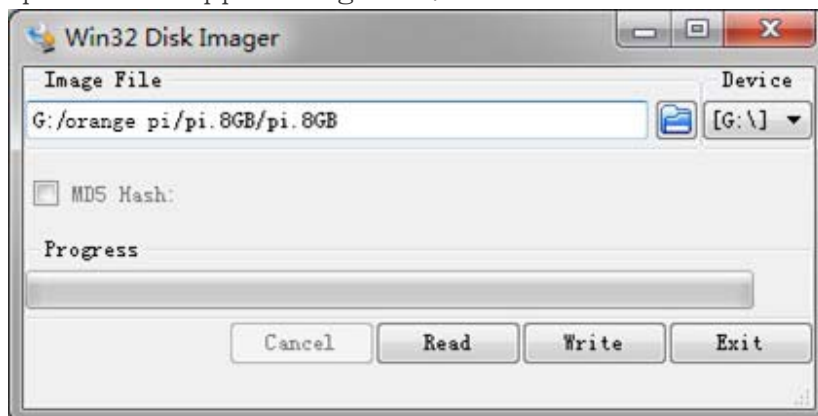



- iii. Click “Write” button. Wait patiently to successfully complete writing.

Linux:

1. Insert your TF card into your computer. The size of TF should be larger than the OS image size, generally 4GB or greater.
2. Format the TF card.
 - i. Run `fdisk -l /dev/sd x` command to check the TF card node.
 - ii. Run `umount /dev/sd xx` to unmount all the partitions of the TF card.
 - iii. Run `sudo fdisk /dev/sd x` command to configure TF card. Use `o` command to delete all partition of TF card and use `n` command to add one new partition. Use `w` command to save change.
 - iv. Run `sudo mkfs.vfat /dev/sd x 1` command to format the new created partition of TF card as FAT32.

(x should be replaced according to your TF card node)

You can also jump this step under Linux, because write image command `dd` under Linux will format the TF card automatically.

3. Download the OS image from the Downloads webpage.
 - i. Website: <http://www.orangepi.org/downloaded/download.html>
4. Unzip the download file to get the OS image (**exclude android os image, android os image need other burn mode.**).
 - i. Run `unzip [downloaded filename]` command.
5. Write the image file to the TF card.
 - i. Run `fdisk -l /dev/sd x` command to check the TF card node.
 - ii. Verify if the hash key of the zip file is the same as shown on the downloads page (optional).

`sha1sum [path]/[imagename]`

This will print out a long hex number which should match the "SHA-1" line for the TF image you have downloaded

- iii. Run `umount /dev/sd xx` to unmount all the partition of the the TF card
- iv. Run `sudo dd bs=4M if=[path]/[imagename] of=/dev/sd x` command to write image file to TF card. Wait patiently to successfully complete writing. Please note that block size set to 4M will work most of the time, if not, please try 1M, although 1M will take considerably longer. You can use `sudo pkill -USR1 -n -x dd` command to check progress.



Step3: Set up your Orange Pi

According to the set up diagram below, you can easily set up your Orange Pi.

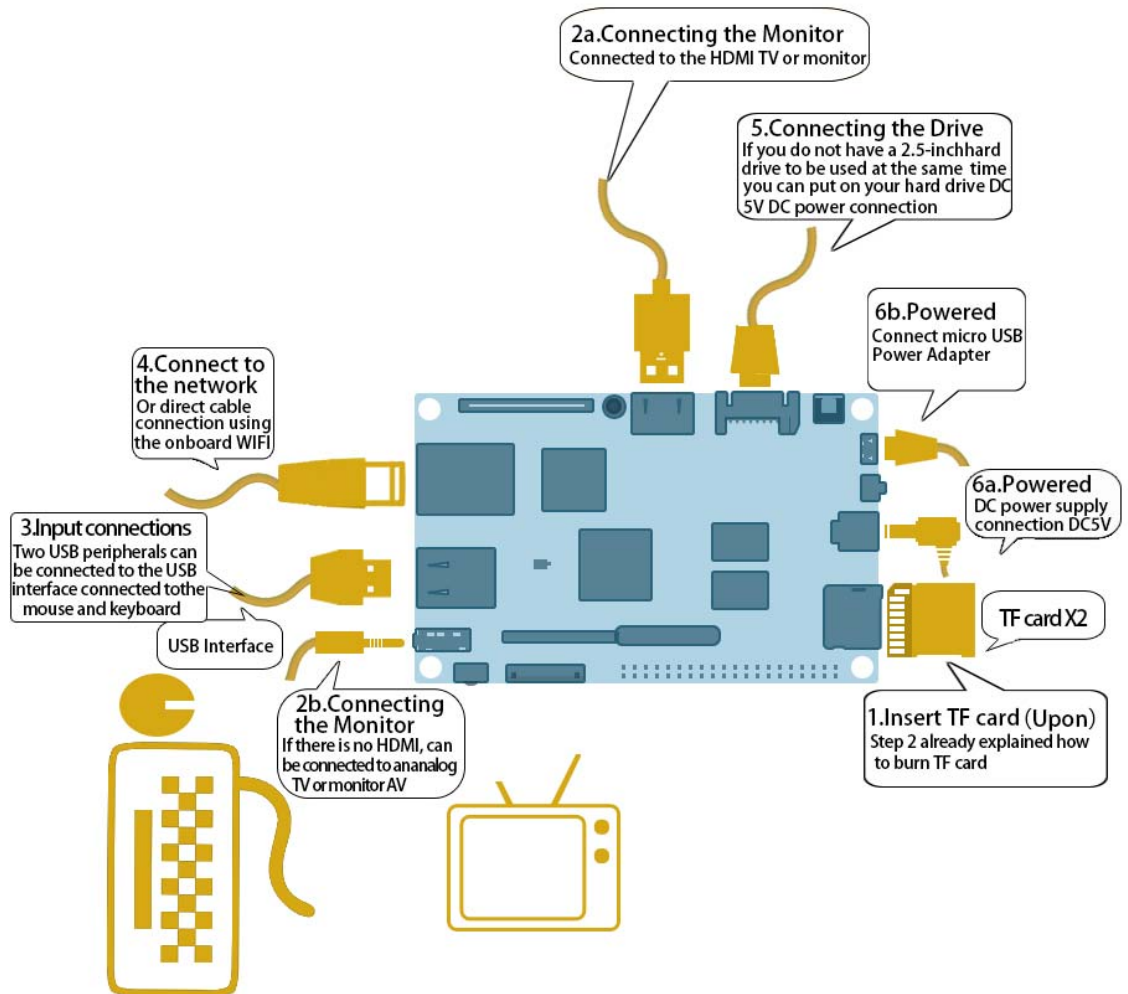

Hardware connect sketch map

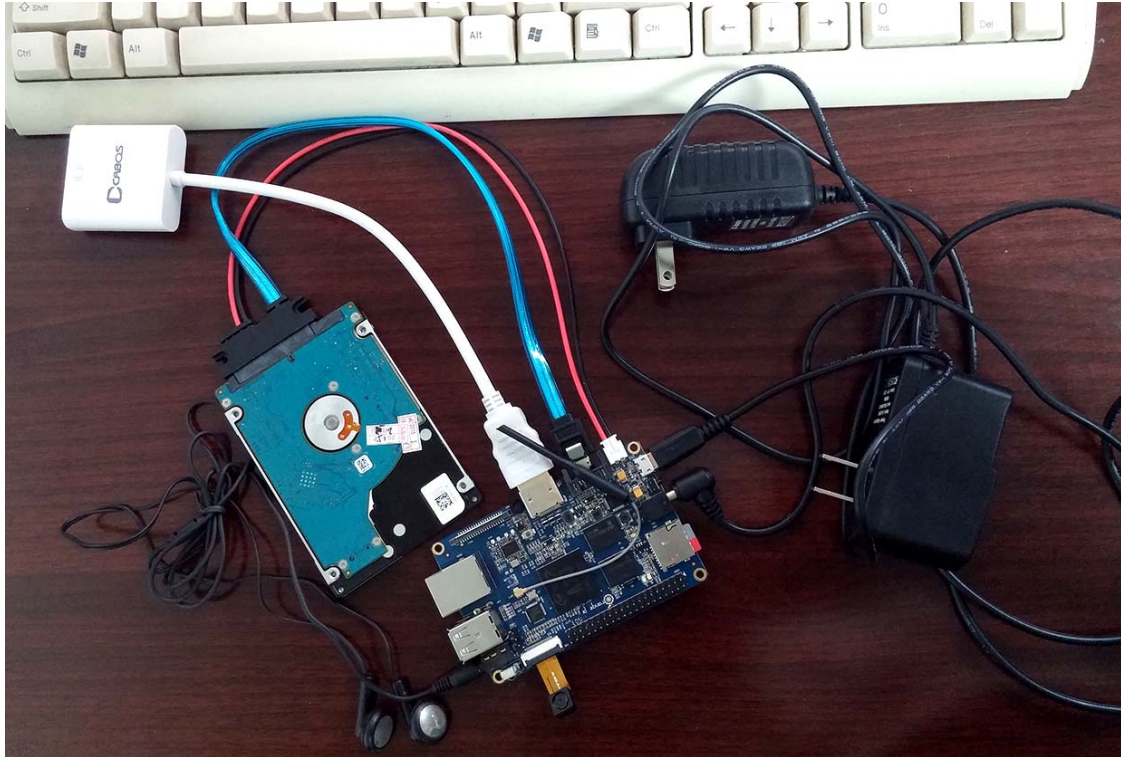

Hardware connect physical map-top view



Hardware connect physical map-bottom view



1. Insert the written-image TF card into the TF card slot on the left side edge of the upside of the board.
2. On the bottom edge in the middle of the board is the HDMI Type A (Full sized) port, just on the right of the SATA port. Just connect any HDMI Type A cable from the board to your TV or HDMI Monitor.

If you don't have an TV/Monitor with a HDMI or DVI-D port you can use the AV jack located on the right edge above USB HOSTs.
3. Plug a USB keyboard and mouse into the USB slots located on the right edge.
4. Just under the USB ports on the right edge is the ethernet connector for anyone who wants to plug the Orange Pi into a wired network. You can also use wifi to connect network.
5. Finally, at the middle of the left edge is the DC power connector. Plug in a regulated power supply that is rated at $5V \pm 5\%$ and at least 1500mA (or 2.0A). Any number bigger than 1500 mA will also work. On the left edge, under the power switch is the micro-usb power connector. Avoid using the smaller chargers used for small GSM phones, as these are often unregulated, even if they claim "5V 2A", they may do "5V" and may do "2A", but not at the same time! Make sure you have the correct USB plug. In the photo below, the mini-USB (on the left) is the wrong one. It's thicker and looks like a trapezoid with its sides pinched in. The micro-USB (on the right) is the correct one. It is thinner and also looks like a trapezoid except it's sides are rounded outward.





Note : The micro-usb power connector can only make *Android* system startup, and the SATA is not available. If you want to start all available systems(such as *Android, Lubuntu*), or want to test SATA, you need to use DC power connector.

6. If you have a free 2.5 inch hard drive, you can put it into use on Orange Pi. Connect the SATA cable to the SATA port just on the left of HDMI. Remember to put the power cable with 2 male 2.54mm headers into the SATA power. Then you can plug your hard drive into the other side of the SATA cable. Be careful with the connection of different color cables. (This step can be skipped)

If all goes well, the Orange Pi will boot in a few minutes. The screen will display the OS GUI(Graphical User Interface). The first boot of a new OS can sometimes take a long time. Be patient! Subsequent boots are usually much quicker.

Step4: Shut down your Orange Pi

You can use the GUI to shut down the Orange Pi safely. Also you can run the command in the terminal:

```
sudo halt
```

or

```
sudo shutdown -h.
```

This will shut down the PI safely, (just use the power key to turn off mightdamage the TF-cards file system). After that you can press the power key for 5 seconds to turn it off.

If all is well ,so you can use orange pi now.

GPIO specification

Orange Pi 40-pin GPIO

Orange Pi has a 40-pin GPIO header that matches that of the Model A and Model B



Raspberry Pi. Following is the Orange Pi GPIO Pinout:

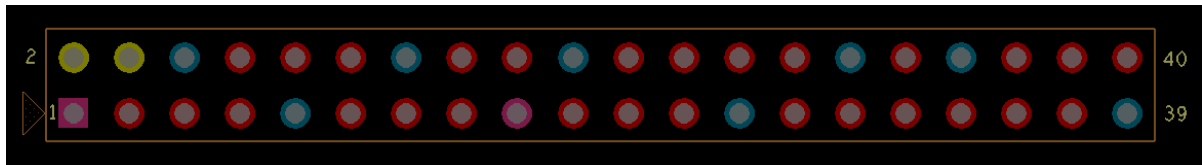

Orange-Pi-Mini-40pin

CON2-P01	VCC-3V3	
CON2-P02	VCC-5V	
CON2-P03	TWI2-SDA	PB21
CON2-P04	VCC-5V	
CON2-P05	TWI2-SCK	PB20
CON2-P06	GND	
CON2-P07	PWM1	PI3
CON2-P08	UART3_TX	PH0
CON2-P09	GND	
CON2-P10	UART3_RX	PH1
CON2-P11	UART2_RX	PI19
CON2-P12	PH2	PH2
CON2-P13	UART2_TX	PI18
CON2-P14	GND	
CON2-P15	UART2_CTS	PI17
CON2-P16	CAN_TX	PH20
CON2-P17	VCC-3V3	
CON2-P18	CAN_RX	PH21
CON2-P19	SPI0_MOSI	PI12
CON2-P20	GND	
CON2-P21	SPI0_MISO	PI13
CON2-P22	UART2_RTS	PI16
CON2-P23	SPI0_CLK	PI11
CON2-P24	SPI0_CS0	PI10
CON2-P25	GND	
CON2-P26	SPI0_CS1	PI14
CON2-P27	I2S_MCLK	PB5
CON2-P28	PI12	PI12
CON2-P29	I2S_BCLK	PB6
CON2-P30	GND	
CON2-P31	I2S_LRCK	PB7
CON2-P32	UART7_TX	PI20
CON2-P33	I2S_D00	PB8
CON2-P34	GND	



CON2-P35	I2S_DI	PB12
CON2-P36	UART7_RX	PI21
CON2-P37	SPDIF_DO	PB13
CON2-P38	PH3	PH3
CON2-P39	GND	
CON2-P40	PH5	PH5

LVDS specification

LVDS (LCD display interface)

The LVDS Connector is a 40-pin FPC connector which can connect external LCD panel (LVDS) and touch screen (I2C) module as well. The pin definitions of this connector are shown as below. This is marked on the Orange Pi board as “CON2”.

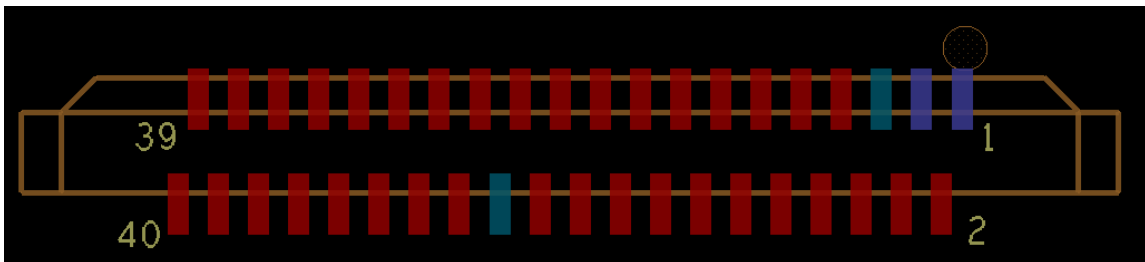

Orange-Pi-Mini-LCD

CN11-P01	IPSOUT	
CN11-P02	TWI3-SDA	PI1
CN11-P03	IPSOUT	
CN11-P04	TWI3-SCK	PI0
CN11-P05	GND	
CN11-P06	LCD0-I00	PH7
CN11-P07	LCDI0-03	PH12
CN11-P08	LCD0-I01	PH8
CN11-P09	LCD0-D00	PD0
CN11-P10	PWM0	PB2
CN11-P11	LCD0-D01	PD1
CN11-P12	LCD0-I02	PH9
CN11-P13	LCD0-D02	PD2
CN11-P14	LCD0-DE	PD25
CN11-P15	LCD0-D03	PD3



CN11-P16	LCD0-VSYNC	PD27
CN11-P17	LCD0-D04	PD4
CN11-P18	LCD0-HSYNC	PD26
CN11-P19	LCD0-D05	PD5
CN11-P20	LCD0-CS	PH6
CN11-P21	LCD0-D06	PD6
CN11-P22	LCD0-CLK	PD24
CN11-P23	LCD0-D07	PD7
CN11-P24	GND	
CN11-P25	LCD0-D08	PD8
CN11-P26	LCD0-D23	PD23
CN11-P27	LCD0-D09	PD9
CN11-P28	LCD0-D22	PD22
CN11-P29	LCD0-D10	PD10
CN11-P30	LCD0-D21	PD21
CN11-P31	LCD0-D11	PD11
CN11-P32	LCD0-D20	PD20
CN11-P33	LCD0-D12	PD12
CN11-P34	LCD0-D19	PD19
CN11-P35	LCD0-D13	PD13
CN11-P36	LCD0-D18	PD18
CN11-P37	LCD0-D14	PD14
CN11-P38	LCD0-D17	PD17
CN11-P39	LCD0-D15	PD15
CN11-P40	LCD0-D16	PD16

CSI Camera Connector specification:

CSI Camera Connector

The CSI Camera Connector is a 24-pin FPC connector which can connect external camera module with proper signal pin mappings. The pin definitions of the CSI interface are shown as below. This is marked on the Orange Pi board as “CON9”.

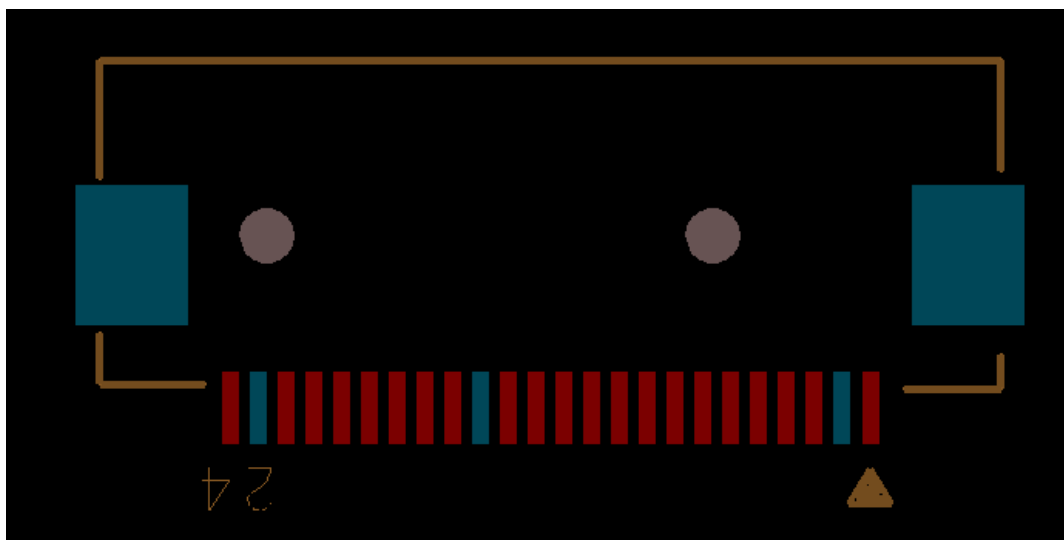

Orange-Pi-Mini-CSI

CN8-P01	IPSOUT	
CN8-P02	GND	
CN8-P03	TWI1-SDA	PB19
CN8-P04	VCC-CSI	
CN8-P05	TWI1-SCK	PB18
CN8-P06	CSI0-RESET#	PH14
CN8-P07	CSI-VSYNC	PE3
CN8-P08	CSI0-STBY-EN	PH19
CN8-P09	CSI-HSYNC	PE2
CN8-P10	VDD1V5-CSI	
CN8-P11	VCC-CSI	
CN8-P12	CSI-D7	PE11
CN8-P13	CSI-MCLK	PE1
CN8-P14	CSI-D6	PE10
CN8-P15	GND	
CN8-P16	CSI-D5	PE9
CN8-P17	CSI-PCLK	PE0
CN8-P18	CSI-D4	PE8
CN8-P19	CSI-D0	PE4
CN8-P20	CSI-D3	PE7
CN8-P21	CSI-D1	PE5
CN8-P22	CSI-D2	PE6
CN8-P23	GND	
CN8-P24	AFVCC-CSI	